

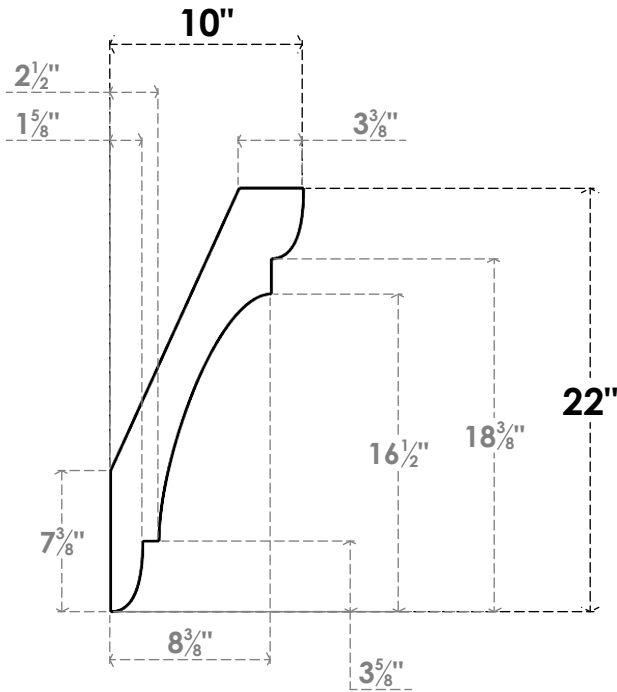

# ITEM NUMBER: BRCPC055X10000X22000OLY

5 1/2"W X 10"D X 22"H OLYMPIC ARCHITECTURAL GRADE PVC CLOSED KNEE BRACE



**SIDE PROFILE**

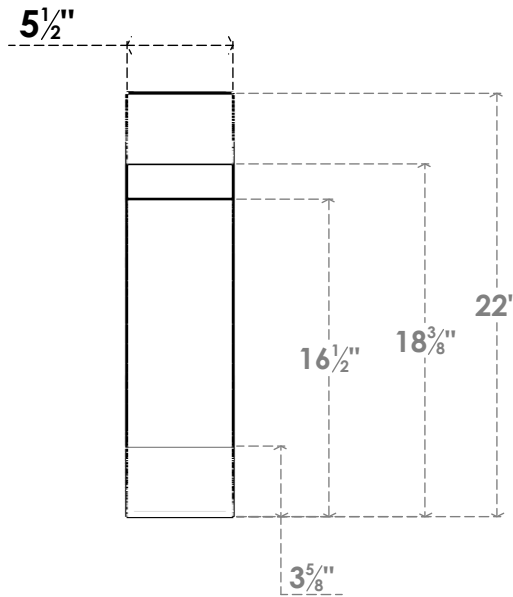

**FRONT PROFILE**

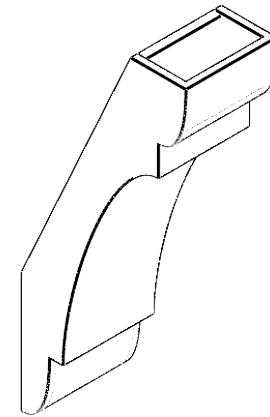

**ISOMETRIC**



EKENA MILLWORK  
2300 WEST MAIN ST.  
CLARKSVILLE, TX 75426  
TOLL FREE: 866-607-0453  
WWW.EKENAMILLWORK.COM

NOTES

1. INSTALLATION TO BE COMPLETED IN ACCORDANCE WITH MANUFACTURER'S SPECIFICATIONS.
2. DRAWING MAY NOT BE TO SCALE
3. THIS DRAWING IS INTENDED FOR DESIGN AND PLANNING PURPOSES ONLY.
4. ALL INFORMATION CONTAINED HEREIN WAS CURRENT AT THE TIME OF DEVELOPMENT BUT MUST BE REVIEWED AND APPROVED BY THE PRODUCT MANUFACTURER TO BE CONSIDERED ACCURATE.
5. ARCHITECTURAL GRADE PVC PRODUCTS ARE MADE FROM EXPANDED CELLULAR PVC AND COME NATURALLY WHITE BUT MAY BE PAINTED

GENERATED DATE : 04/25/2023